

GreenTek®

Trusted by the best in the game

GREENS GROOMER

OPERATOR'S MANUAL



INTRODUCTION

Congratulations on purchasing a first-class high quality GreenTek product, engineered to give years of use provided it is used and maintained correctly.

To ensure operator safety and obtain maximum service life from this machine it is essential that ALL operators read and thoroughly understand this manual. If at any time there is anything you are unsure about, the manufacturers will be pleased to help.

MACHINERY MARKINGS

Your machine carries the following information. Please quote your serial number when ordering spare parts.

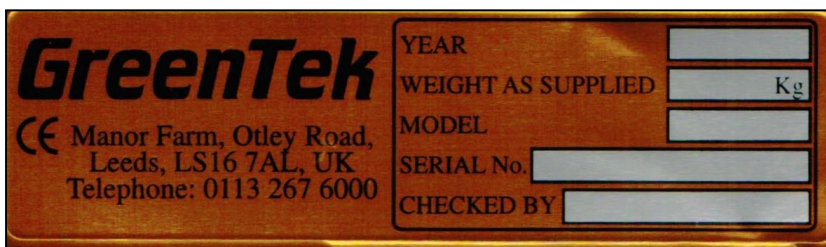

APPLICATION

The Greens Groomer is designed for brushing greens, fairways and artificial pitches. It can be used to brush-in topdressings very effectively, also to remove dew, and stand up to grasses before mowing.

This equipment is designed solely for brushing sports and amenity turf. Use in any other way is contrary to the intended use.

The manufacturer accepts no liability for damage or injury resulting from misuse. Compliance with the instructions in this manual is essential for safe operation.

SAFETY WARNINGS

Always wear suitable protective clothing (eg, gloves and steel toecap footwear), especially when coupling/uncoupling to towing vehicle.

Make sure on electric models the leads don't trail on the ground.

Watch out for obstacles/bystanders; remember the triple model is wider than the towing vehicle.

REMEMBER: IT IS THE OPERATORS RESPONSIBILITY TO ALWAYS ENSURE THAT THIS MACHINE IS IN SAFE WORKING ORDER BEFORE USE AND THAT CONDITIONS ARE

SUITABLE FOR IT TO BE USED WITHOUT ENDANGERING THE OPERATOR OR OTHERS.

WARNING DECALS

The following decals are affixed to your Greens Groomer which must be obeyed at all times. replacement decals are available free of charge from the manufacturers.

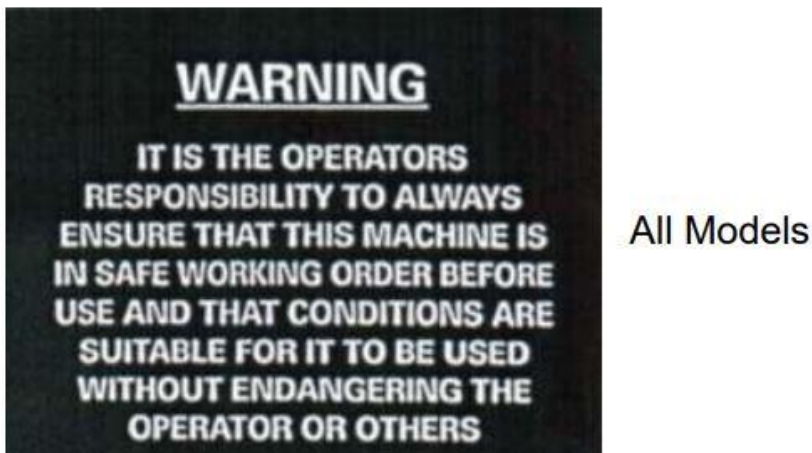

OPERATING INSTRUCTIONS

SINGLE TOWED UNIT

Attach the drawbar to the hitch of tow vehicle. Lower the Greens Groomer completely to the ground. Loosen the lock nut on the carriage head bolt that holds the height adjustment curved piece in place. Determine that the brush is flat on the ground then tighten the nut. **Grease the wheel bushings before use.** Your Greens Groomer is now ready to use.

TRIPLE GANG

When using a triple gang, the front Greens Groomer unit may need to have its height adjuster set so that the rear end of the brush is slightly raised. When in operation, the drag created by the outer units will then naturally pull the front unit level.

The fold out wing arm assembly for use with the triple gang simply bolts onto the centre section such that, when folded out into the operating position, the lugs which form the drawbar hitch for the rear units are on the top sides of the wing arms.

Each unit is equipped with its own individual control box which should be removed and the leads plugged into the single master control box, when used as a triple gang.

LINKAGE MOUNTED

The 3-point linkage mounted version simply attaches to any standard Category 1 linkage by means of the clevis pins provided.

USING THE SINGLE TOWED GREENS GROOMER

The Greens Groomer is pulled onto the edge of the green in the transport mode. At this time, the operator lowers the brush by using the electric actuator to 'raise' the wheels. Raise the wheels until they are off the ground. Pull the brush at appropriate speed to agitate the sand. Too slow or too fast results in sub-standard brush action. Somewhere between 4mph and 6mph gives the best results. Make sure the Greens Groomer is level when being pulled. When finished, raise the brush and move to the next green.

Normally, only 1 or 2 passes on dry sand are required to properly complete topdressing. One suggestion: start in a circular pattern around the green. When the turns become too tight, cut the remaining sand in half, forming two 'D' patterns. When the first pass is complete, repeat the procedure going the opposite direction. Alternatively, simply travel across the green from side to side raising the groomer up as you reach the edge, then proceed off the green to make your turn avoiding turf scuffing and reducing wheeled traffic on your green.

The unit is equipped with a telescopic drawbar which can be extended to allow use in tandem behind a truckster mounted topdresser.

OPERATING REAR-MOUNTED SYNTHETIC PITCH RAKE AND BRUSH

An optional rear mounted rake and brush is available for grooming and decompacting synthetic pitches. The rake has 3 rows of adjustable spring tines and will give either a light grooming or a heavy decompacting. The brush on the rear is also adjustable and levels infill material and stripes the surface. **Before using check with the pitch supplier as to the correct procedure for your pitch.**

MAINTENANCE

The Greens Groomer needs very little maintenance or upkeep. **Always** wash the brushes off after use. This ensures that wet topdressing packed in the brushes does not cause them to take an incorrect 'set'. **Never** store the Greens Groomer on the brushes, or again the possibility of an incorrect 'set' can occur. When not in use, set the Greens Groomer on the 'Jack Stand' to prevent any weight from being placed upon the brushes.

Wheel bushings should be greased before each use. When greasing, make sure all excess grease is wiped off to prevent any from falling on the ground. Remember that the Greens Groomer sees a lot of sand during operation so it is important to keep the bushings greased.

Tyre pressure should be 15lbs.

If brushes should take a 'set' or curve in one direction due to use, simply reverse the drawbar hitch by unbolting the 3 bolts and re-attaching the hitch and height adjustment bar to the back.

EXTENSION WINGS INSTALLATION INSTRUCTIONS

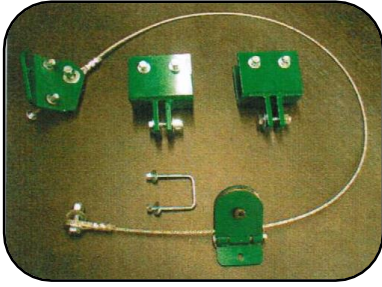

Extension Wings Accessories

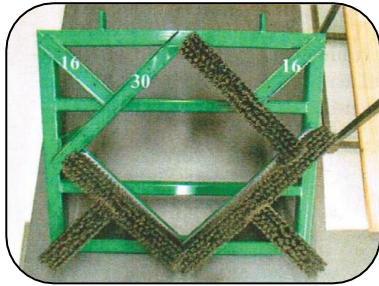

Attach the 2-16" and 1-30" brushes included to each wing

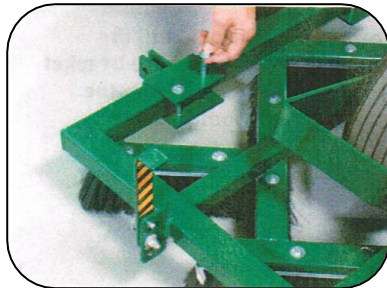

Attach extension wing brackets to the main frame of the Groomer. Do not tighten.



Attach each wing to the two extension wing brackets. Only tighten to a snug position so that the wings will fully rotate.

GREENS GROOMER

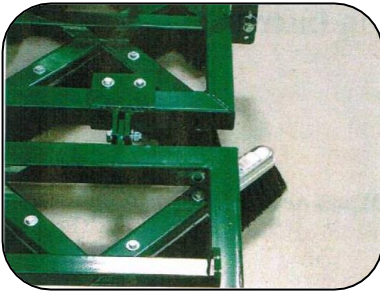

Align the frame of each wing with the frame of the Groomer. Fully tighten the two bolts of the extension wing brackets.



Attach the cable bracket to the upright arm of the wheel assembly on the Groomer. Attach one end of the cable to the bracket.



Attach the cable sheave bracket to the frame of the Groomer. The sheave bracket should be placed 26-1/2 inches from the outside of the Greens Groomer frame.

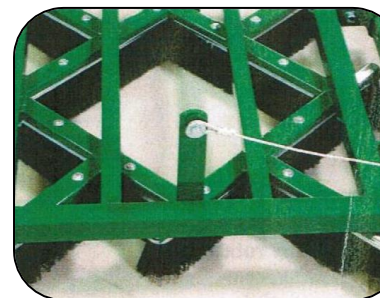

Attach the loose end of the cable to the upright arm of each wing.

Your Greens Groomer with extension Wings is now ready for use. The wings will automatically raise when the tyres of the Greens Groomer are lowered for transport. For narrow passages such as bridges or for long distance transports, each wing may be folded up by hand and strapped together for safety.

GreenTek[®]

Trusted by the best in the game

Tel: +44 (0)113 267 7000
Email: info@greentek.uk.com
Web: www.greentek.uk.com

REPLACEMENT BRUSH SETS

We recommend brushes are purchased as full set, replacing individual brushes will mean that the new brushes will touch the turf as they are longer and the old brushes will not work.

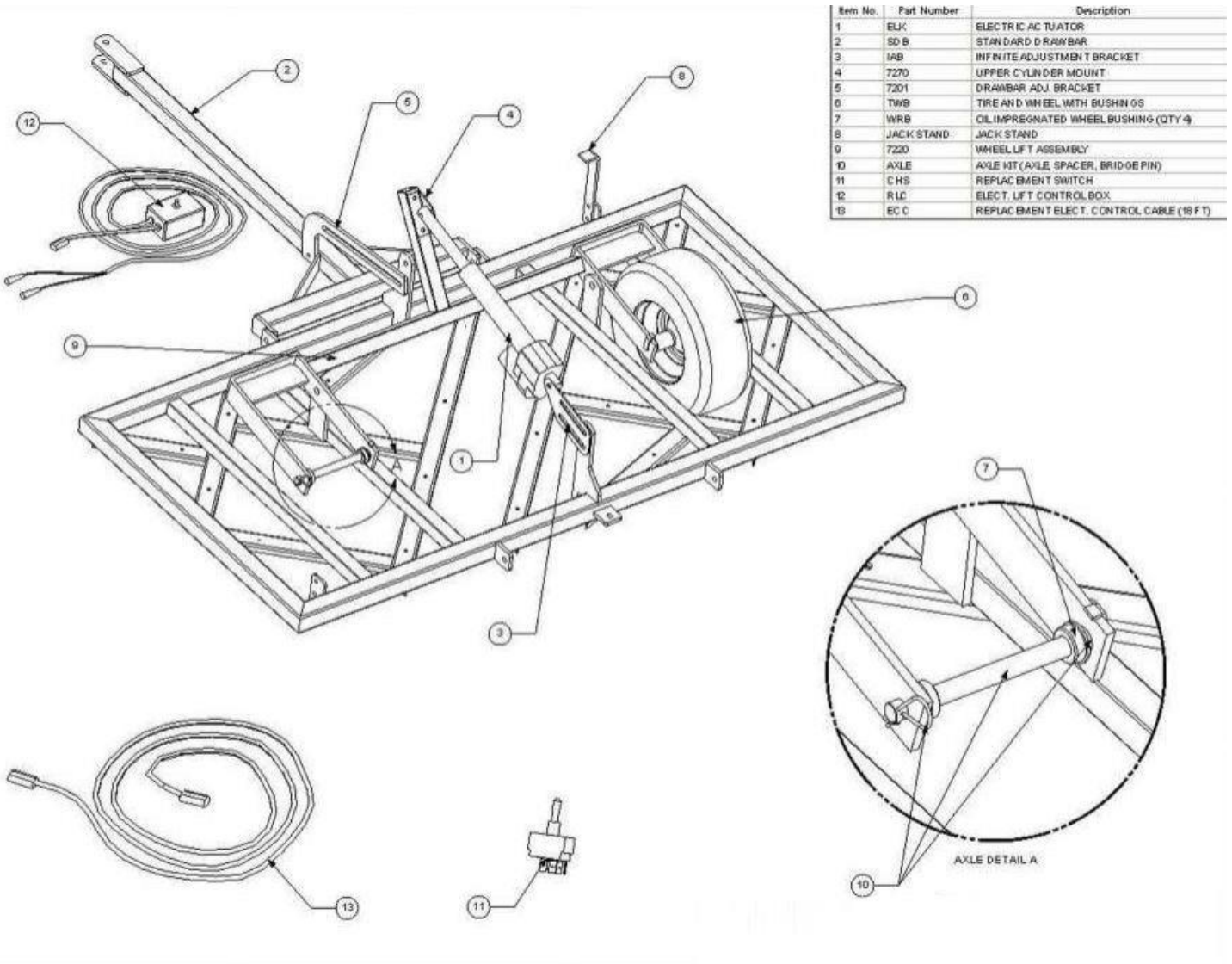

Certificate of CE Conformity

Date: 10 February 2003
Machine Model: Greens Groomer
Description: Top Dressing Brush
Serial Number: _____

I hereby certify that the machine detailed hereon conforms to European Directives 89/392EEC as amended 91/368EEC – 93/44EEC – 93/68EEC.

Signed:  _____

(Quality Manager)

GUARANTEE

We guarantee that should any defect in materials or workmanship occur within 24 months of the date of purchase we will repair, or at our option, replace the defective part free of charge provided that the fault is reported to us immediately it becomes apparent.

Damage caused by normal wear, misuse or in transit is not covered by this guarantee.

CONTACT US

For further information, support or advice please contact:

info@greentek.uk.com

+44 (0)113 267 7000